

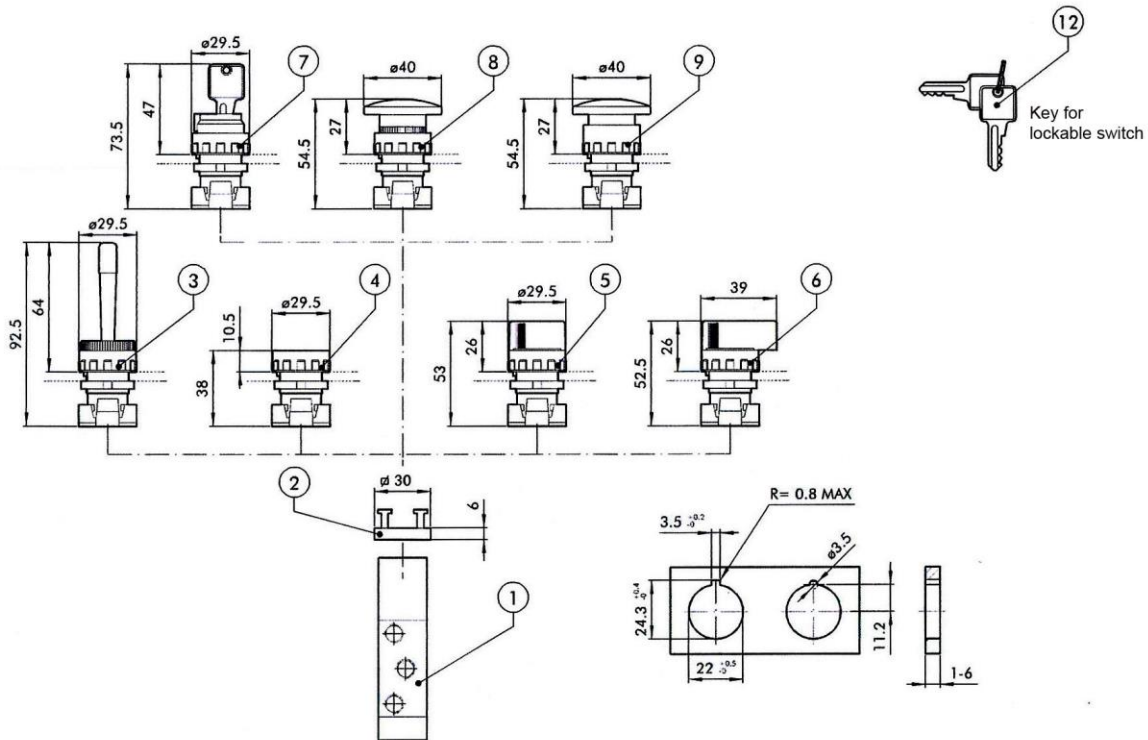

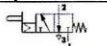

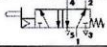











For the following way valves:
 Art. No. 512.111 to 512.704
 Art. No. 515.201 to 515.701
 Art. No. 515.211 to 515.711

Ident No. 106397 to 106416
 Ident No. 106417 to 106428
 Ident No. 106429 to 106440

ORDERING CODES

Symbol	Ident No.	Reference	Art. No.	Description	Weight [g]
	106441	①	515.101	Pilot-assisted plunger 3/2, 1/8"	124
	106442	①	515.111	Pilot-assisted plunger 5/2, 1/8"	150
	106443	②	A2V	2 places adaptor thickness 6.8 mm	5
	106445	③	HH-M	Red handler with horizontally pivoted lever	25
	106444	④	DK-M	Fat push button + 2 red/black coloured disks	15
	106446	⑤	KDH-2M	Black selector short lever at 2 positions with return	20
	106447	⑤	KDH-2B	Black selector short lever at 2 positions	20
	106448	⑤	KDH-3M	Black selector short lever at 3 positions with return	20
	106449	⑤	KDH-3B	Black selector short lever at 3 positions	20
	106450	⑥	LDH-2M	Black selector long lever at 2 positions with return	26
	106451	⑥	LDH-2B	Black selector long lever at 2 positions	26
	106452	⑥	LDH-3M	Black selector long lever at 3 positions with return	26
	106453	⑥	LDH-3B	Black selector long lever at 3 positions	26
	106454	⑦	V2SS-JS	2 positions key selector with extractable key in 2 positions	50
	106455	⑦	V2SS-GS	2 positions key selector with extractable key in 0	50
	106456	⑧	RPT-M	Red mushroom-head push button $\varnothing 40$	27
	106457	⑧	RPT-M	Black mushroom-head push button $\varnothing 40$	27
	106457	⑨	RPT-NR	Red mushroom-head push button with lock $\varnothing 40$	29